

### RS232

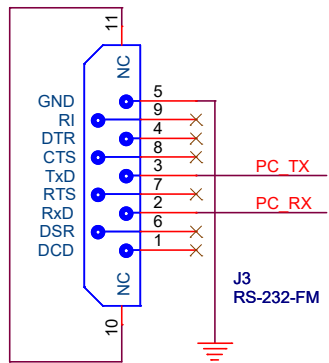

### TTL

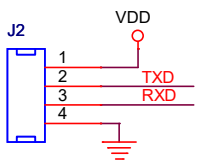

### DC input

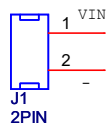

### Servo

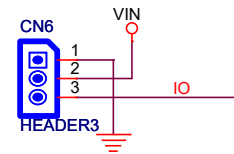
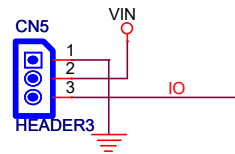
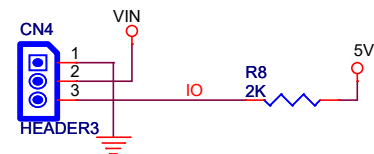
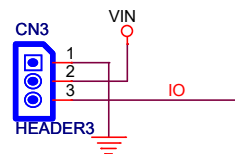
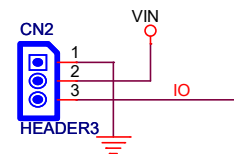
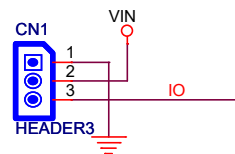

Title		
<Title>		
Size	Document Number	Rev
Custom	<Doc>	0.1
Date:	Tuesday, March 17, 2026	Sheet 1 of 1